

birkdale 

Driven by Quality Dedicated to You

September 2020

Insulated Roller Garage Door Brochure

Birkdale Professional 78 and 55



15 Years
Colourfast Warranty



7 Years
Motor Warranty

78 PROFESSIONAL IN CHARTWELL GREEN



5 Years
Door Monitor System Warranty

NEW
Widest range of Insulated
Roller Garage Door colours
and material finishes
<http://birkdale.co.uk/panel/colours/>

WHY CHOOSE BIRKDALE?

Birkdale Manufacturing Group Limited is a well established British Manufacturer, employing a large, highly skilled and diverse number of employees across the UK.

Formed in 1992, by Simon Sturman, customer service and satisfaction have always been key. From humble beginnings, the company has expanded its product range and have continued to invest in new technologies to suit our customer's changing requirements. Continually adjusting to improve the quality of product has ensured that we produce some of the finest products in Europe and remain leaders in our field.

If you are looking for a high quality product at a competitive price, Birkdale will provide this for you.

WHAT CAN WE OFFER?

For almost 30 years, we have specialised in high quality garage doors and roller shutters, and in more recent years have increased our range to include; Composite Front Entrance Doors, Window Security Shutters, Awnings, Pergolas, Patio Enclosures, Home Automation and much more.

Based in North Lincolnshire, our multi-skilled team of Manufacturers ensure our products are tested and reach the necessary requirements in line with European Safety Regulations.

Our reliable and dedicated team work hard to meet your expectations and ensure you have an end product to be proud of.

HOW DOES IT WORK?

Our National Network of approved installers will happily carry out a free on-site survey and offer professional, honest advice and recommend the right product for you at a competitive price.

Once you have made your choice, a deposit will secure your order and will be followed up by a highly skilled installation service, if required, anywhere in the United Kingdom.

We thank all of our customers past and present and hope to serve you in the near future,

Birkdale Team

CONTENT

Welcome to Birkdale	Page 2
Insulated Roller Garage Doors	Page 3
Our Range	Pages 4 - 6
Insulation & Security	Page 7
Lifestyle	Pages 8 - 9
Automation & Remote Control	Pages 10 - 11
Product Features and Options	Pages 12 - 16
Technical Specification	Page 17
Birkdale Professional Range Specification	Page 18
Garage Door Wi-Fi Kit	Page 19
Roller Door Warranty Details	Page 20
Sectional Garage Door - Introduction	Pages 21-23

INSULATED ROLLER GARAGE DOORS

PROFESSIONAL 78 and 55

take less
space
than
any other

Insulated roller garage doors take less space than any other garage door and have "no outswing". You can park your vehicle right up to the door leaving more available space on your drive way.

SPACE SAVING

Ideal for extra storage space and excellent for short driveways.

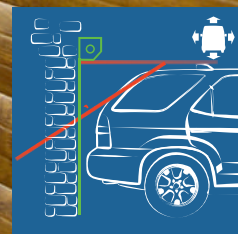

78 PROFESSIONAL IN GOLDEN OAK



78 PROFESSIONAL IN WINE RED

*Please check out our range of Front Entrance Doors on www.birkdale.co.uk

Visually they look stunning with gentle curves and subtle lines. You can choose the colour that best suits your home and your choice. With no restrictions you can choose a colour that suits your preference.

To Suit Most Garage Designs.

Our doors can be installed to most designs of garage. One of the most popular designs is an arched headed lintel.

If you have two single sized garage doors with a centre pillar, and you would like to change this to one double sized door, the centre pillar can be removed, and one double sized insulated roller door will create the solution.

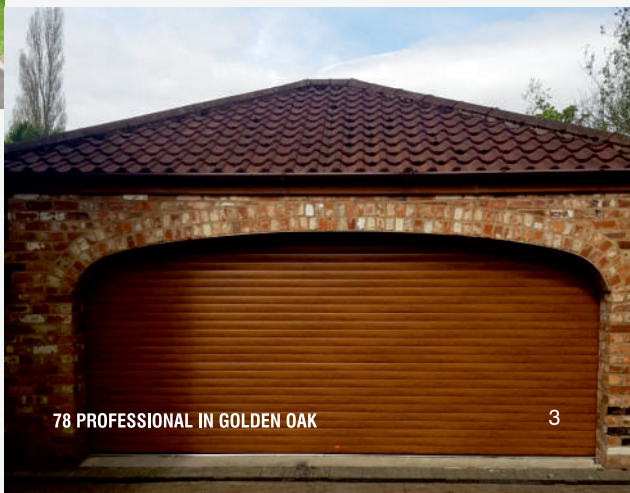

78 PROFESSIONAL IN GOLDEN OAK

OUR RANGE

At Birkdale we have invested in the very latest technology and manufacturing techniques. This has enabled us to manufacture Insulated Roller Doors to an exacting high standard and introduce ranges of colours and finishes that are unique in the garage door market.

“Laminated Finish” what does this mean?

Laminated or “Foiled” are two descriptions of the same process. At Birkdale, we have our own in-house technology which enables us to “lamine” our Polyester smooth aluminium materials. This creates a much more resilient surface that is far more able to survive against climatic changes and abrasion, and importantly, retain the superb appearance you originally enjoyed with your door. With the built in solar shield technology the Laminate increases the insulation value up to 60%*.

Background image shows closeup of White Woodgrain laminate foil.

Laminate material is used across many industries including; automotive, house building, furniture manufacturing and many more.

Using the very highest quality of Laminate material, Birkdale can provide a surface of our garage doors that carry a 15-year warranty against colour fading. We can provide literally 1000s of colour choices in several appearances.

Continuing our range of unique colours and finishes, you can choose from our “Colour Matched Laminated Finish Range”.

This range offers you any choice of colour you may wish for. Any colour that is not included in the “Polyester Smooth Finish” “Trend Laminated Finish” or “Trend Plus Laminated Finish” can be supplied from this range.

For us to manufacture this special range of colours, we go through several stages of our process including laminating each lath individually to then put each lath through our “PLASCOAT” colour treatment process. “PLASCOAT” is widely used in the UPVC and Aluminium front entrance door market and has an extraordinary tough and resilient finish.

We hope we have provided enough information for you to choose a Birkdale Insulated Roller Door.

However please go to birkdale.co.uk should you require further information.

* Against Polyester Finish.

Background image shows closeup of Walnut laminate foil

OUR RANGE

Polyester Smooth Finish



This is our entry level Polyester Finish

Trend Laminated Finish

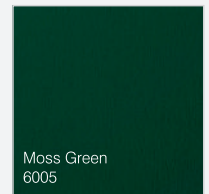
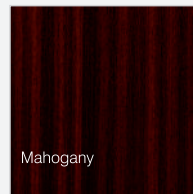
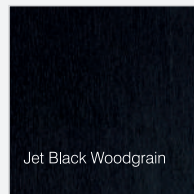
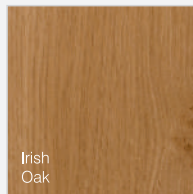
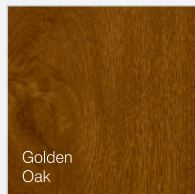
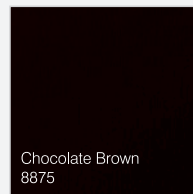
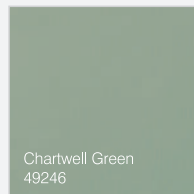
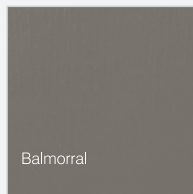
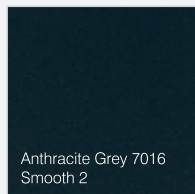
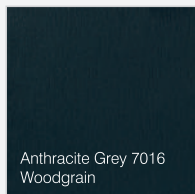

A range of the most popular colours in our laminated finish; Anthracite Grey (smooth and woodgrain), Balmorral, Chartwell Green, Chocolate Brown, Cream White, Crystal White Ash, Golden Oak, Irish Oak, Jet Black (woodgrain), Mahogany, Moss Green, Mountain Oak, Slate Grey and Steel Blue. These are offered at a subsidised rate because of their popularity.



SCAN WITH YOUR MOBILE TO OPEN THE TREND LAMINATED COLOUR SWATCH

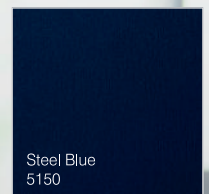
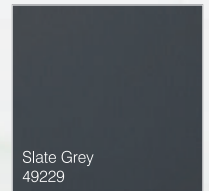
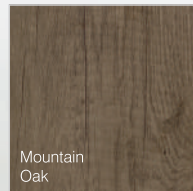



15 Years
ColourfastWarranty

TREND AND TREND PLUS LAMINATED FINISHES COMES WITH 15 YEAR COLOURFAST WARRANTY

Trend Plus Laminated Finish
Has over 50 colour choices



SCAN WITH YOUR MOBILE TO OPEN THE TREND PLUS LAMINATED FINISH COLOUR SWATCH

BACKGROUND PICTURE SHOWS 78 PROFESSIONAL IN WINE RED

Colour Matched Laminated Finish

We can manufacture to colour match your specific colour and to any colour that is not RAL recognised.

Colour Matched Laminate Finish "PLASCOAT" is a unique range of colours and technology only from Birkdale. This range offers all colours from all colour ranges. In order to manufacture this range we use PLASCOAT colour treatment on top of our a laminated lath. This creates a colour finish which is far better than any other painted coloured lath.



WE'VE EVEN BEEN ASKED TO MATCH THE COLOUR OF A BIRKDALE DOOR TO A PLANT POT



SCAN WITH YOUR MOBILE TO OPEN THE COLOUR MATCHED LAMINATED FINISH COLOUR SWATCH

INSULATION AND SECURITY



KEEP AWAY THE
NOISE



SO YOU CAN
RELAX



HELPS TO KEEP YOU
WARM



PROTECTS FROM
COLD

The Professional range provides insulation and acoustic properties that are much greater than most garage door products.

The aluminium lath is constructed as a double walled substrate with a CFC Free Polyurethane injected foam infill. Offering high performance, weather sealing and good insulation.

We build our 78 and 55 ranges using the very best materials. When manufacturing insulated roller garage doors, it is extremely important that the correct guides are used and that the top and bottom of the door curtain are strengthened. We achieve this by using wider guides than are required and we use extruded aluminium top and bottom laths*

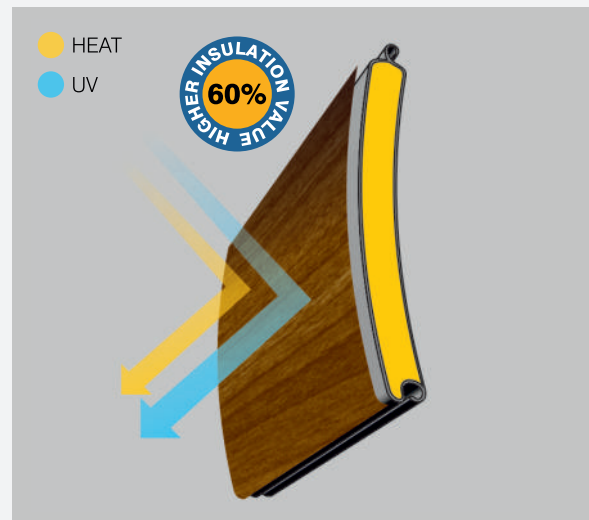

CFC Free Polyurethane foam within the Aluminium Lath Plus high performance weather sealing ensures good insulation

SECURITY MATTERS



*Professional 78 only.
** Supplied with Somfy and Sommer as standard.

78 PROFESSIONAL IN MAHOGANY



Extruded guides, top and bottom rails all add to the overall performance of our range providing superior strength to your Professional garage door



Alarm your door for even greater peace of mind. If there is an attempt to force your door open from the bottom, a piercing sound will deter the would-be intruder**

Lifestyle

You can see from the appearance of these images how much a Birkdale door will improve your home. Remote controlled Birkdale doors help ease your quality of life also.



78 PROFESSIONAL IN ANTHRACITE GREY



78 PROFESSIONAL IN CUSTOM COLOUR TO MATCH PLANT POTS



78 PROFESSIONAL IN GOLDEN OAK



78 PROFESSIONAL IN WHITE SMOOTH



78 PROFESSIONAL IN WHITE SMOOTH



78 PROFESSIONAL IN GOLDEN OAK



55 COMPACT IN GOLDEN OAK



55 COMPACT IN CHARTWELL GREEN



78 PROFESSIONAL IN WINE RED



55 COMPACT IN WHITE SMOOTH



78 PROFESSIONAL IN BLACK



78 PROFESSIONAL IN GREY



78 PROFESSIONAL IN GOLDEN OAK



78 PROFESSIONAL IN IRISH OAK

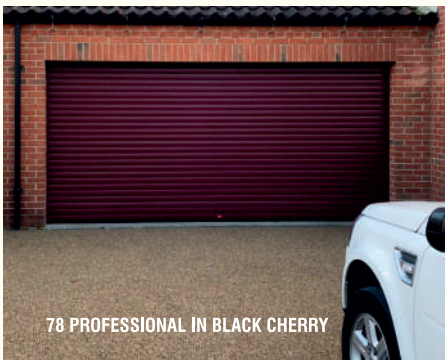

78 PROFESSIONAL IN BLACK CHERRY

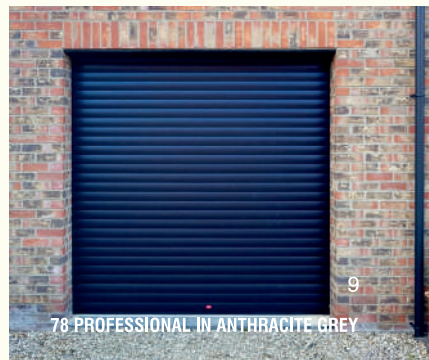

78 PROFESSIONAL IN ANTHRACITE GREY

AUTOMATION & REMOTE CONTROL

Remote Control.

Remote control operation of your Professional range of doors is supplied as standard. At a touch of a button on your hand set you can open / stop / close your garage door either separately or in multiple openings, giving you peace of mind.

If your door should close on an obstacle during its closing cycle, the safe edge systems we supply as standard under CE regulation will send a signal back to the door monitoring unit, signalling the door to stop and reverse. Once you are comfortable in the knowledge that your door is once again safe, you can operate your hand transmitters in the normal manner.

Inside of your garage you will have a wall mounted control unit. This unit has another operating switch for you to operate in the open / stop / close directions.

The control unit also includes a timed LED light that illuminates both from your hand transmitters and the operating button on the unit.



DMS - Door Monitoring System by Birkdale WITH TOUCH SCREEN CONTROLS AND COURTESY LED LIGHT

This unique control system offers so much more. The front panel is touch screen technology. As is the wireless digital entry Key Pad (optional). The system monitors the opening and closing of your door not only sensing under the bottom edge rubber but also sensing the front and rear of your door during its operation. It includes LED lighting. Battery status indicator. Safe edge status indicator. You can also add the options of an alarm to deter would be intruders. You can also access your control system through your *Somfy Smart Home Automation.

*Somfy controls are an option.



We offer
different types
of control box!

Depending on your preference, choose a system that matches other items, gates, window blinds, awnings etc. No matter what your other home automated products are Birkdale can compliment them.

RDC Vision⁺

- ⌘ TÜV type-tested certification
- ⌘ Standard-compliant safety switch-off in acc. with Cat. 2, Pld
- ⌘ Bi-directional, secure radio system thanks to 128-bit-AES encryption
- ⌘ Integrated evaluation of 8.2 kOhm or optical safety edge
- ⌘ Convenient connection via pluggable



SOMMER

somfy

ROLLIXO RTS

Combined with a proven wireless safety edge system to detect obstacles and an array of safety, security and comfort accessories, the Somfy motor and Rollixo RTS control combination is a complete and compliant system.



Why a roller door?



Space Saving



Made to Measure



Aesthetically Pleasing



Secure



Increased Insulation



Improved Acoustics



Vertical opening for shorter driveways



More Colours



Choice of Control Systems



Harder Wearing Finish



British Made

This is our most popular roller door. 300mm of headroom is ideally required to house the box and is made from 78mm x 20mm foam filled slats to suit openings up to 5300mm wide. 6.5kg/m².

The Professional door requires headroom which is not always available. To accommodate this Birkdale have designed the Compact Roller Door. These doors still share many of the features of a Professional door and allow installation into smaller spaces.

Choose

PROFESSIONAL 78



 **CURTAIN**
6.5 kg/m²



Choice of colours offering 1000's of finishes with colour fast warranties up to 15 years.







15 Years
Colourfast Warranty

Birkdale

ROLLER DOOR

Key to features and options for further details see next pages



- 1  Alarm
- 2  Battery Backup
- 3  Hand Transmitters
- 4  Vision Lath
- 5  Keypad
- 6  Half Box
- 7  Full Box
- 8  Colour Matching
- 9  Hood Lock
- 10  Box Strengtheners
- 11  Tube Motor
- 12  Three Function Spring System
- 13  Internal Manual Override
- 14  Through Wall Drive
- 15  Heavy Duty Barrel
- 16  Autolocks



Colour matching Guides and Fascia

Trend, Trend Plus and Colour Match Laminate finish range include white guides and box as standard. You can choose the colour of your guides and box as an option.

PRODUCT FEATURES & OPTIONS



ALARM

For added security an Alarm can be fitted to sound when the door is being tampered with forcefully or manually lifted. The alarm will only work in conjunction with the Door Monitoring System (Option with DMS, standard with Somfy and Sommer control systems.).



BATTERY BACKUP

Add the Battery Backup and never worry about power failure again. Just carry on operating your door as normal waiting for power to return (option).



HAND TRANSMITTERS

Two and four channel hand transmitters can be supplied to operate up to four doors using one handset (two channel handset is supplied as standard).



VISION LATH

Vision lath enable you to have windows in your door. The lath can be colour matched to some colours but not all of the ranges and where applicable there will be a difference in the textured appearance (option).

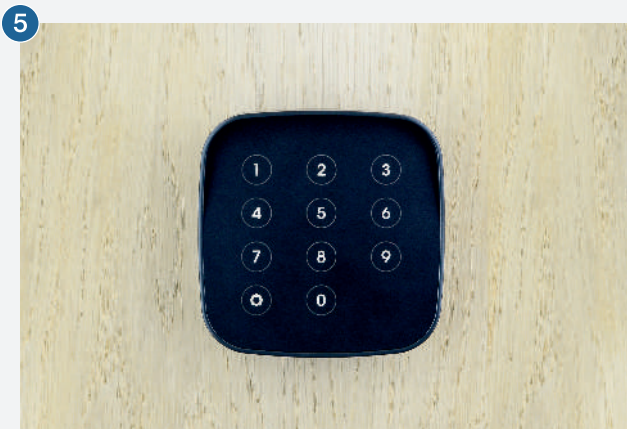

WIRELESS KEYPAD

Add a Keypad to an outside wall for access to your garage without the need to carry hand transmitters (option).



HALF BOX

An aluminium half box made up from a 90° profile to create a fascia when headroom is limited (option).

Picture above shows Half Box and 125mm reinforced barrel with attached 78mm curtain.



FULL BOX

An aluminium box made up from a 90° and a 45° profile to create a fascia when headroom is limited and a neat finish inside the garage. A full box is required for external fitting (option).



COLOUR MATCHING

Matching guides boxes and half boxes are options for Trend, Trend Plus and Colour Matching ranges.

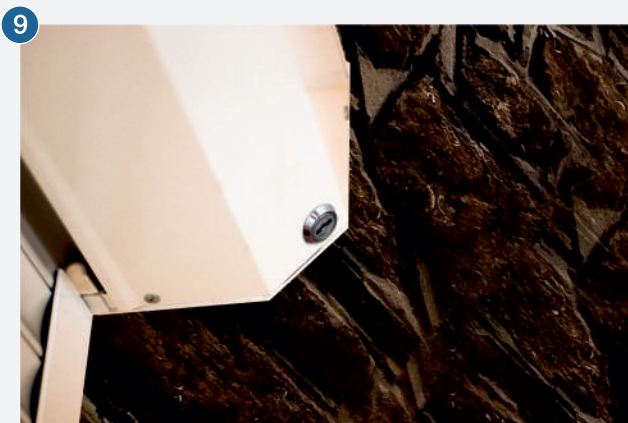

HOOD LOCK

A lockable cover for externally fitted roller doors to secure the manual release device (option).



BOX STRENGTHENERS

Full Box Fascia Strengtheners are optional for greater rigidity.

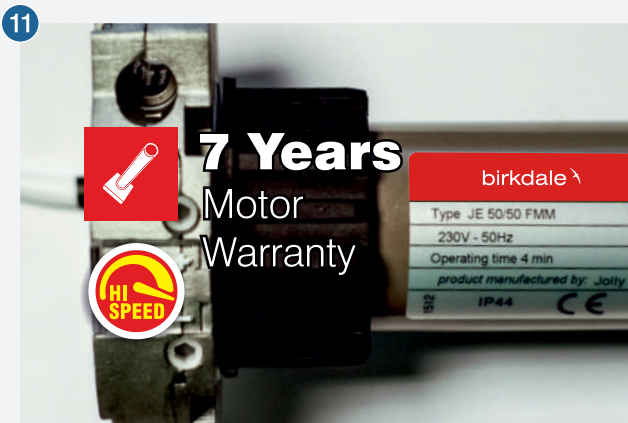

HIGH SPEED TUBE MOTOR

A high speed motor provides smoother and faster operation. Supplied with an internal manual release and a **7 year warranty**. These are supplied exclusively to Birkdale by a **European Manufacturer**.

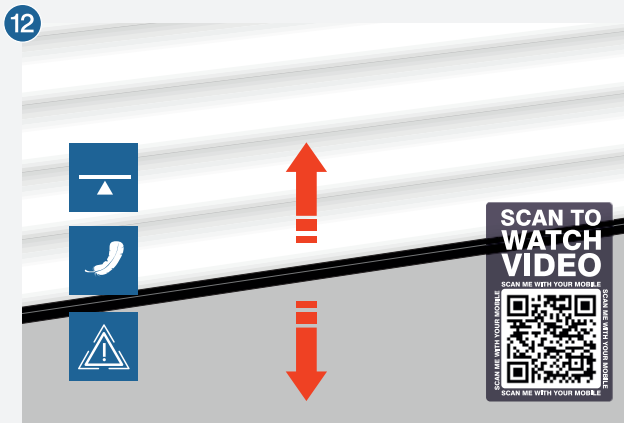

3 FUNCTION SPRING SYSTEM

This reduces the work load on the motor, gives a smoother door operation, and provides a much more reliable safety-drop system.

PRODUCT FEATURES & OPTIONS



INTERNAL MANUAL OVERRIDE

In the event of a power cut, our internal manual override allows the door to be wound up and down via crank handle and eyelet (left pic.). This can be upgraded to a permanently fixed knuckle system (right pic.) which is ideal for tight spaces. Our spring assisted system makes this easier to use.

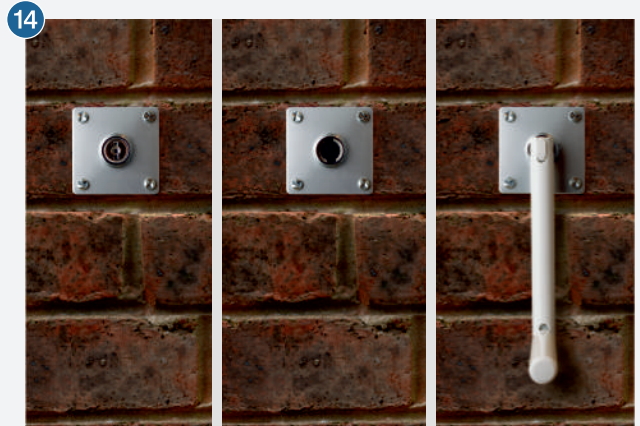

THROUGH WALL DRIVE

For all garages with no other entrance a Through-Wall-Drive is to be fitted as an external manual release, in the event of power failure. Secured with anti theft screws. An internal gearbox ensures easy operation (Option).



HEAVY DUTY BARREL

The 125mm round aluminum barrel is light weight but extremely strong with its honeycomb structure eliminates any deflection in the barrel even in doors at 5300mm wide. The increase in the diameter of the barrel also significantly increases the speed and smoothness of the door operation and with the additional retainer profile provides much superior reliability on longer doors.

This is supplied as standard on doors over 4000mm and is available as an optional extra on doors below this. Please note box dimensions vary between 70 and 125mm barrels. See the diagrams below.



Autolocks*

The built in Autolocks are designed to hold the door down tight with a spring clamp device. Each one is tested to withstand 30kg of upward pressure and last a cycle of 10,000 operations.

* Only with conjunction with 70mm Barrel.

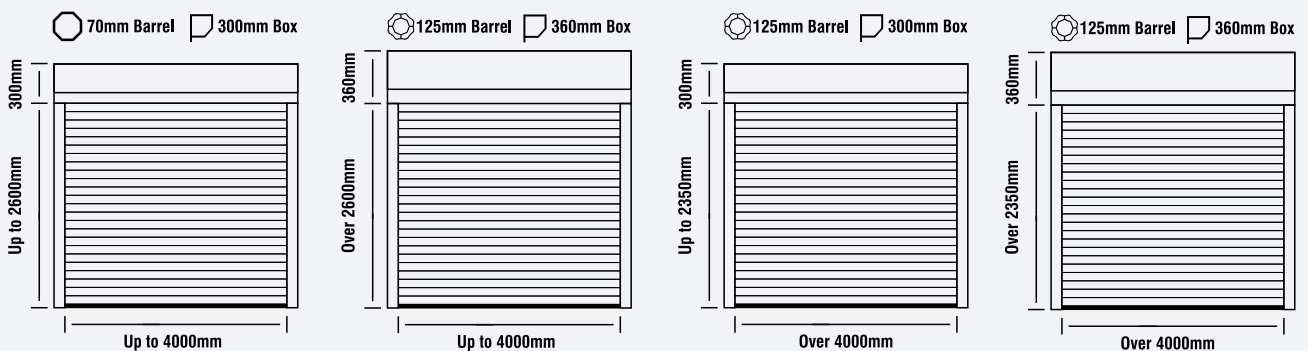



Technical Specification

Fitting requirements and roller door features comparison.



Headroom

This is the required space needed to accommodate the diameter of the door as it rolls up and down.

This can be created by using the Full Box (see page 13) particularly for under lintel or external fitting.

Fixing Examples

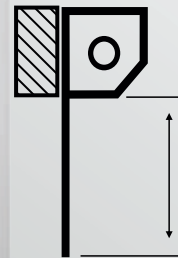

Opening Height

- Above lintel fix.

The Full Box (see page 13) is not required for headroom purposes.

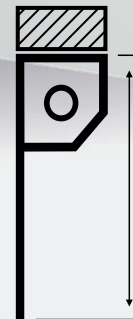

Overall Height

- Under lintel fix

No headroom
The Full Box (see page 13) creates a fascia to give the headroom required.

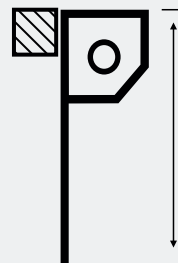

Overall Height

- Limited headroom

The Full Box (see page 13) creates a part fascia to give the headroom required.



Side room

The side room applies to the space which is needed to fit the guides on both sides of the garage aperture. The size of the tracks will vary depending on the selected roller door model and their width size..The size of the tracks will vary depending on the selected roller door model and their width sizes.

The guides can be face fixed or fixed in between (see diagram).

Opening Width

- Face fix

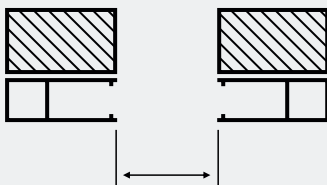

Overall Width

- In between fix

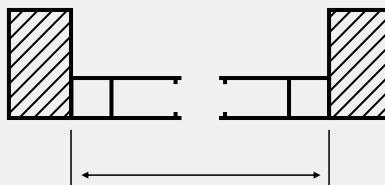

Overall Width

- Face and in between fix

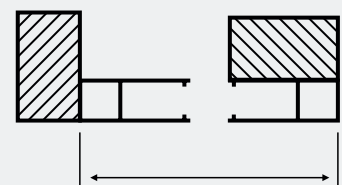

If in doubt please ask, we are here to help.

BIRKDALE PROFESSIONAL RANGE SPECIFICATION

Item	Professional 78	Compact 55
Max width (Over guide width)	5300mm	3000mm
Max height (Guide Height)	3500mm	2590mm
Min headroom	300mm up to 2350mm GH	205mm
Max headroom	360mm from 2600mm GH	250mm
Min sideroom	70mm	75mm / 66mm for 205mm Boxes
Max sideroom	100mm for doors over 4000mm wide	75mm
Fixing options	Internal / External	Internal / External
Laminated finish	Trend / Trend Plus / Colour Matched	Trend / Trend Plus / Colour Matched
Polyester finish	Standard	Standard
Colour matching options	Guides / Boxes*	Guides / Boxes*
Polyester matching guide colour	Standard	Standard
Trend/Trend Plus/Colour matched guides	White as standard	White as standard
Trend/Trend Plus/Colour matched guides	Matching Laminated colour**	Matching Laminated colour**
Guide sizes	70mm / 100mm	66 / 75mm
Half box Trend/Trend Plus laminate finish	Matching Laminated colour**	Matching Laminated colour**
Lath depth	20mm Polyester / 21mm Laminated	14mm Polyester / 15mm Laminated
Vision lath polyester finish	Optional	N/A
Vented lath polyester finish	Optional	N/A
Motor speed	15 / 17 RPM	17 RPM
Manual override type	Crank handle	Crank handle
Manual override type (Through Wall Drive)	Lockable Crank Handle	Lockable Crank Handle
Steel Barrel	70mm octagonal up to 4000mm OGW and 2600mm OGH	60mm octagonal
Heavy Duty Aluminium Barrel	125mm reinforced from 4000mm OGW	N/A
Locking - Autolocks	Up to 4000mm OGW and 2600mm OGH	Autolocks
Locking - Retainer Profile	Heavy duty profile from 4000mm OGW	N/A
Full box	Optional	Standard
Half box	Optional	Optional
Full box strength brackets	Optional	N/A
Basic Controller - No Safety	N/A	Standard
Door monitoring system (DMS)	Optional	Optional
Somfy wireless control system	Optional	Optional
Sommer wireless control system	Optional	Optional
Sommer hard wired control system	Optional	Optional
Hood lock	Optional	Optional
Wireless digital entry keypad DMS	Optional	Optional
Alarm for DMS	Optional	Optional
Courtesy light	Standard	Standard
Battery back up	Optional	Optional
2-channel hand transmitter DMS	Standard	Standard
4-channel hand transmitter DMS	Optional	Optional
3 metre mains power cable	Optional	Optional

*1/2 Box only with Trend / Trend Plus, **(Outside surface only)

WARRANTY DETAILS

PLASCOAT finishes	10 years	10 years
Laminate finishes	15 years	15 years
Polyester finishes	5 years	5 years
DMS/Safety Edge	5 years	5 years
Motor	7 years	7 years

OGH - stands for Over Guide Height - Which is the opening height of the garage drive through.

OGW - stands for Over Guide Width - Which is the opening width of the garage drive through + guides.



Safe Distancing and Secure Delivery

Never miss a delivery again, accept deliveries away from home!

Kit is available as a part of Birkdale Smart Home Solutions and can be fitted to most makes of garage door automation.



Good morning,
I have a parcel for you
but it seems nobody
is in....



Oh Hi! We're away.
I'll open the garage door
for you, please leave it there.



Done!

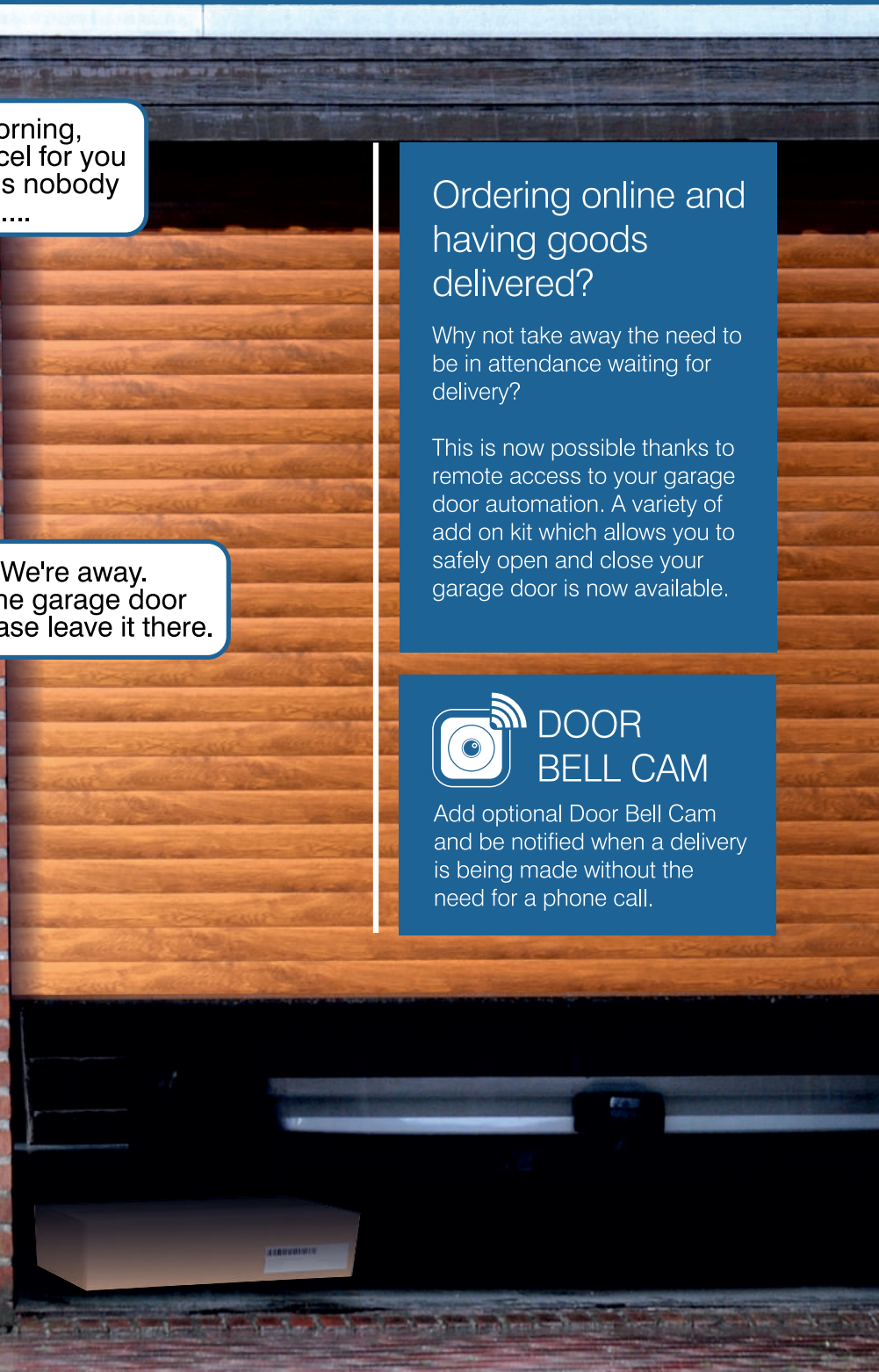

Ordering online and having goods delivered?

Why not take away the need to be in attendance waiting for delivery?

This is now possible thanks to remote access to your garage door automation. A variety of add on kit which allows you to safely open and close your garage door is now available.

 **DOOR BELL CAM**

Add optional Door Bell Cam and be notified when a delivery is being made without the need for a phone call.

ROLLER DOOR WARRANTY

All products are independently tested to the highest standards and are certified to the high safety requirements and performance characteristics of European Standard 13241-1. You can, therefore, be confident that your purchase of a Birkdale product is a safe investment. Guarantee Birkdale offers the following warranty for garage door and garage door automation products:

1. SUMMARY (subject to the terms and conditions outlined in sections 2-7 below): Free 12 month Parts & Labour Guarantee. Thereafter Parts only Guarantee.

All functional parts are guaranteed for a minimum of 1 year. We only ask that these are fitted by our engineers. During the first year, our engineer's time and labour are free if the product has been registered by visiting <https://birkdale.co.uk/warranties/>. The guarantee does not include items which are consumable such as batteries, fuses or light bulbs.

5 years safe and reliable operation (for use up to 5 open and closing cycles per day).

5 years integrity of the door slats(s) / curtain.

5 years slat corrosion (inside and out) *please refer to section 5 for Sea Salt corrosion.

5 years All immoveable frame parts.

7 years Motor and mechanical parts.

1 year Operator control unit (5 years if Door Monitor System is used).

2 years All mechanical elements of the doors, including rollers and springs (5 years if Door Monitor System is used).

2 years All remote control parts (excluding batteries, bulbs and fuses).

2 years All remote control Accessories.

1 year Warranty on all commercial applications unless otherwise agreed (maintenance agreement).

2. REQUIREMENTS

The warranty only covers damage to the purchased garage door or garage door operator. The fully completed warranty card/service record (to be updated annually), together with receipt of purchase, correspondingly substantiates your right to claim under warranty. Warranty claims are only accepted in the country where the garage door/operator was purchased. The product must have been purchased through our authorised distribution channels. If installed by a dealer/contractor not approved by Birkdale then consequential costs for installation and de-installation, inspection of parts, transport and postage costs will not be accepted by Birkdale. Replacement parts are chargeable and credited on return of proven faulty goods.

3. PERFORMANCE

During the warranty period we undertake to rectify any and all defects to the Birkdale product which can be proved to be attributed to a material or manufacturing fault. We promise, at our discretion, to either exchange the defective merchandise, repair or allow a reduction in price. Replacement parts remain our property.

4. THIS WARRANTY DOES NOT COVER DAMAGE CAUSED BY:

Improper installation and negligent care and maintenance, however, if Birkdale carry out any installation work Birkdale offer a 3 months warranty on installation workmanship. Birkdale do not cover installations carried out by other parties.

Improper initial and subsequent operation.

Negligent or wanton destruction.

External influences, such as: fire, water, salts, alkaline solutions, acids and any abnormal environmental influences (this also includes high winds and Acts of God).

Mechanical damage, through improper transport and fitting, or through falling or hitting objects.

Improper use of surface protection treatments.

Repair by non-qualified persons.

Using non-Birkdale parts without the written approval of the manufacturer.

Removal of the product number, or making it unidentifiable.

Application of additional, non approved weights or infills.

Failure to remove the protective film or packaging provided with the product, where applicable.

This warranty applies to all goods sold on or after 1 May 2016, until further notice.

The finish of white powder coated doors is guaranteed for a period of 5 years. In the case of laminated doors with a textured woodgrain finish, the exterior finish is guaranteed to provide an effective weatherproof membrane which will resist perforation. Furthermore, colour change or fade to the exterior surface will be limited and uniform for the full 15 year period. The proper aftercare procedures must be carried out to maintain the 15 year warranty on the finish; regular cleaning of the door both inside and out is essential to remove any dust / dirt build up. This can cause marks to appear in the grain if proper care is not upheld.

5. SEA SALT CORROSION

Doors fitted within coastal areas can be susceptible to corrosion from the salt air. Salt air deposits will settle on the door and can eventually cause corrosion to the aluminium. Cleaning the door regularly with warm soapy water once a month will slow this process down and prolong the life of the aluminium significantly. Doors fitted within 5 miles of the sea are NOT covered by the standard Birkdale warranties. The warranty for aluminium against corrosion in coastal areas is 18 months. This applies to powder-coated aluminium and steel sections.

5.1 SECTIONAL GARAGE DOOR AND SHUTTER AUTOMATION

Birkdale electric motors are guaranteed against any form of manufacturing defect for a period of 5 years for mechanical elements, motors and transformers. The motor control unit is guaranteed for 2 years. Remote control accessories and parts

are guaranteed for a period of 2 years. No warranty claims will be accepted for wear and tear parts and consumable parts (e.g. light bulbs and batteries)

6. BIRKDALE MANUFACTURER'S GUARANTEE REGISTRATION

6.1 Your purchase of a Product has the benefit of a manufacturer's guarantee ("Guarantee"), which covers your product for 12 months from date of purchase provided you register the product online or using the postcard given to you on delivery. Please refer to the certificate of Guarantee contained within the box of your purchase for more information. Our Guarantee is in addition to your statutory rights. To register your product please visit the following website address: www.birkdale.co.uk/warranty-register then follow the instructions on screen.

7. SPARE PARTS MANUFACTURER GUARANTEE

7.1 Your Spare Part has the benefit of our manufacturer's guarantee ("Guarantee"), which covers your Spare Part if, within twelve months from purchase your Spare Part is proven to be faulty or damaged because of either workmanship or material. Our Guarantee is in addition to your statutory rights.

If you received a faulty or damaged Spare Part(s) within twelve months from the date of purchase you may elect to make a claim pursuant to this Guarantee by contacting our Spare Parts Department on 01724282171.

7.2 REGISTERING YOUR WARRANTY

It is important to register your Birkdale product upon installation to activate your parts and labour guarantee by visiting our product warranty site: <https://birkdale.co.uk/warranties/>. After 12 months of the product being installed, the labour aspect of your cover automatically expires. You can opt to extend your labour guarantee for a further 12 month period with the following options:

The standard 7-day call out labour charge is £150 inc VAT which includes 1 hour labour. This is upgradeable to include 24-hour 7-day emergency call out for £200 inc VAT; this will cover 1 hour labour to secure property even in the event of damage outside of manufacturing warranty (i.e. burglary, storm, impact damage) and can cover securing other doors and windows on site. Please contact us on 01724 282171 in daytime hours or fill in our online contact form for emergency call out. Alternatively, if the product was not registered via the Birkdale Product Warranty site then the warranty has expired and our standard call out charge applies; £250 inc VAT or £300 inc VAT for 24/7 call out and parts are chargeable.

7.3 Please note it takes 2 to 5 business days to process returns once they arrive at our warehouse.

7.4 A full refund will be issued in the same form of payment originally used for the purchase within 3 to 5 business days of us receiving your return. Please allow up to 28 days for funds to appear in your bank account.

7.5 OUR GUARANTEE IS SUBJECT TO THE FOLLOWING CONDITIONS

The product has been registered and activated

Cosmetic damage must be reported within 14 days from the date of purchase.

The Spare Part has been fitted by a suitable qualified or competent person in accordance to our operating and maintenance instructions.

The Spare Part is used in the country of purchase.

Documentary proof of original purchase date is provided.

7.6 OUR GUARANTEE DOES NOT COVER

a) Damage resulting from transportation, improper use, neglect or interference or as a result of improper installation.

b) Accidental damage, this includes but is not limited to, damage which occurs as a result of an external action.

7.7 WE MANUFACTURE SPARE PARTS FOR DOMESTIC USE ONLY.

We understand that in some cases our Spare Parts are used in commercial and/or non domestic situations. We still provide a full 12 months Guarantee subject to the above conditions and that the Spare Part has not been subject to overuse, which is to be determined by us taking into account actual usage versus usage that is expected of a domestically situated appliance.

7.8 COLOURFAST TERMS FOR LAMINATE FINISH

The assessment of any colour change is made according to ISO 105-A02 (grey scale) [Fourth Edition 1993-09-01]. Weather fastness, with respect to colour change, is deemed to exist according to RENOLIT Technical Terms and Conditions of Delivery TL-RENOLIT EXOFOL MX, TL-RENOLIT EXOFOL PX & TL-RENOLIT EXOFOL FX if no grade below grade 3 of the grey scale is attained according to the above mentioned Technical Terms and Conditions of Delivery under test conditions. Due to the variety of climatic conditions and environmental influences in the course of natural weathering and to ensure reproducible results, resistance to weather fastness is assessed according to EN 513 by a Xenon test according to ISO 4892-2. A defect is deemed to exist if, within the Warranty periods specified in the Annex, colour changes occur due to natural weathering which exceed grade 3 of the grey scale of ISO 105-A02. Weather fastness (according to the Technical Terms and Conditions of Delivery) is considered to exist with a view to other (non-colour-related) substantial impairments of the visual appearance when the human eye cannot detect delamination, stains, blisters, streaks, cracks or other impairments in a microscopic evaluation at 20 x magnification. Weather fastness Colour change ≤ grayscale 3 (ISO 105-A02) after samples have received (EN 513, process 1) 20 GJ/m² of radiant energy according to the requirements of RAL-GZ 716.

Also, In The Birkdale Garage Door Range.

A true unique UK manufactured
Insulated sectional door.

Our design teams create doors that are
unrivalled in insulation value, security is at
the forefront of all our Sectional Door
designs.

State of the art production machinery to
ensure your door is exactly what you are
wanting.

What we do.



We listen



We discuss



We create

When the customer is happy we build
and install a true UK manufactured
Sectional Door.



Sizes

We cover them all. Single,
double or even treble.



WHAT WE OFFER

Choices

Choose between 40mm thick panels or our Super Thermal panel at an industry only 50mm thickness.

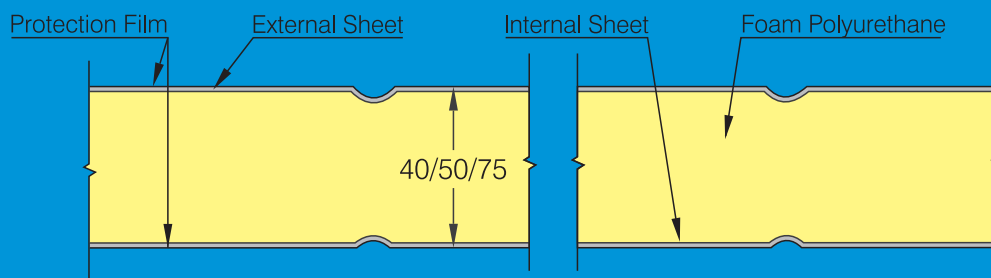

Available panel heights 500 / 555 / 610

Colours

Birkdale as a manufacturer of our own insulated panels can produce a colour of your choosing.

Along with the most popular colours of today we can produce any specific colour for your Sectional Door.



Styles

No two people are the same and as such no Birkdale Sectional Door is the same.

Whether a Georgian style, a micro ribbed or a fully smooth panel we can design and build to your specification.

Perhaps a woodgrain or wood effect , all part of the portfolio here at Birkdale.

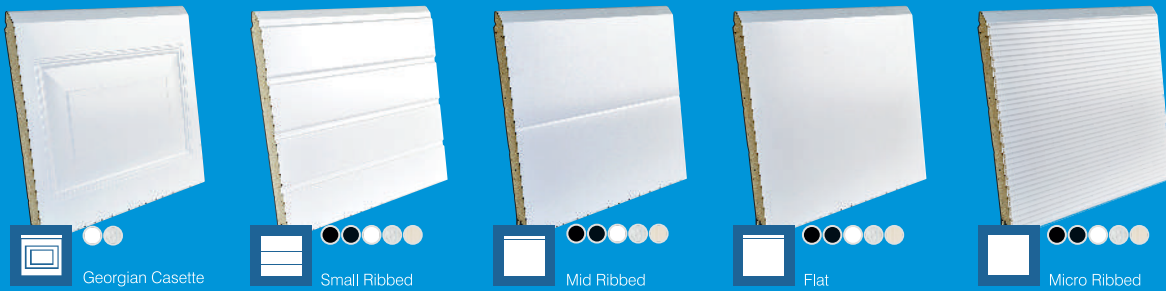

Windows

Stainless or self-colour frames, obscure or clear glazing or even leaded to match an existing entrance door.

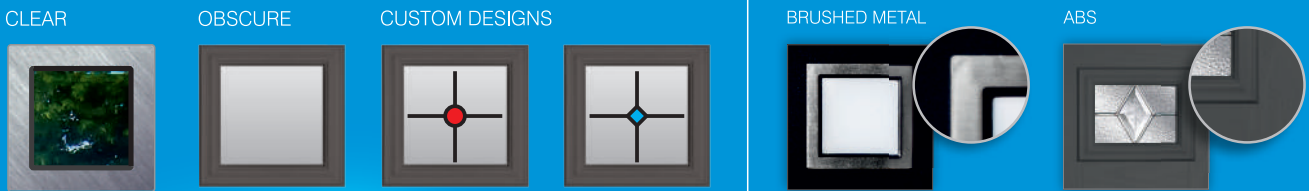

Two types of cassettes are available. Both stylish and high quality to match most architectural styles.

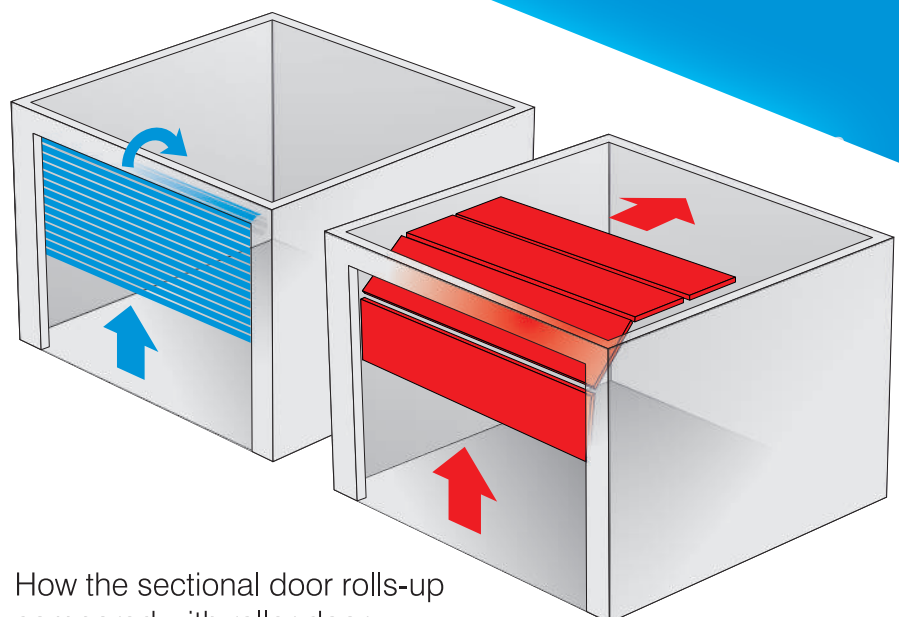

How the sectional door rolls-up compared with roller door.



SECTIONAL DOORS



AWNINGS



PERGOLAS



ROLLER SHUTTERS



COMPOSITE DOORS



INDUSTRIAL DOORS

15 YEARS COLOURFAST WARRANTY
7 YEARS MOTOR WARRANTY
5 YEARS DOOR MONITOR SYSTEM WARRANTY



Birkdale Manufacturing Group Ltd
Unit 1, Eastgate Park
Arkwright Way
Queensway Industrial Estate
Scunthorpe
North Lincolnshire
DN16 1AE

📞 01724 282 171
📠 01724 282 170
✉ sales@birkdale.co.uk
🌐 www.birkdale.co.uk
📍 53.567923, -0.617272

